



Cod. PAGINA 6
Rev. 01.12.2019

VEHICLE (brand/model): CITROEN JUMPY 16 - PEUGEOT EXPERT 16
TOYOTA PROACE 16 - OPEL VIVARO 19

RAMP (mod./size): PC/ME/PLUS from 80 to 100

KIT N.: 71.1204-1



Base fastening - Fissaggio della base - Fixation de la base - Befestigung der Basis - Fijación de la base



1

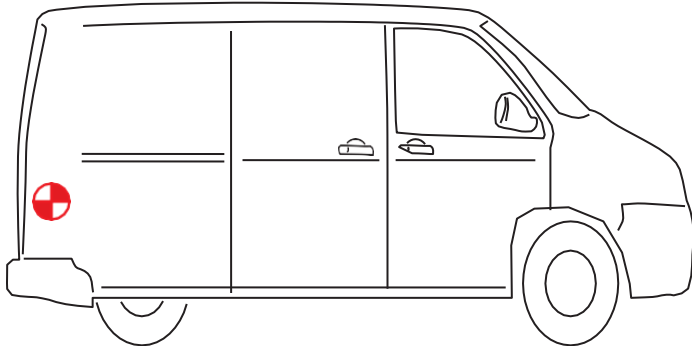

existing holes
fori esistenti
trous existants
vorhandene Löcher
agujeros existentes

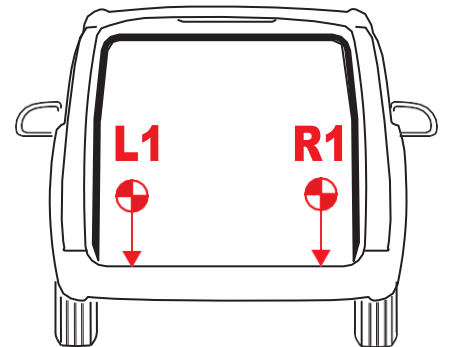

L1

R1

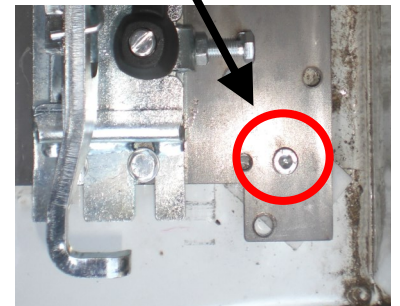
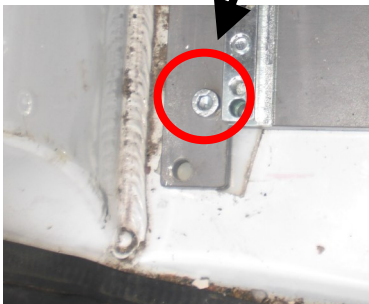

M8 x 30



M8 x 30

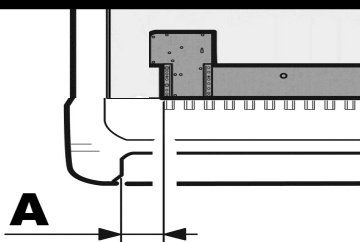

A	B
5 cm	10 cm

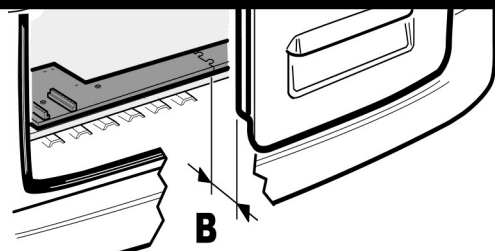

./2

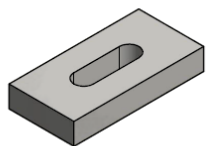

X 4

CODE 41.402

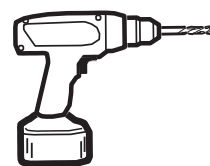

+

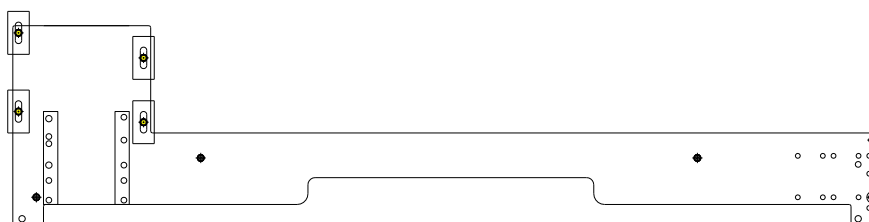
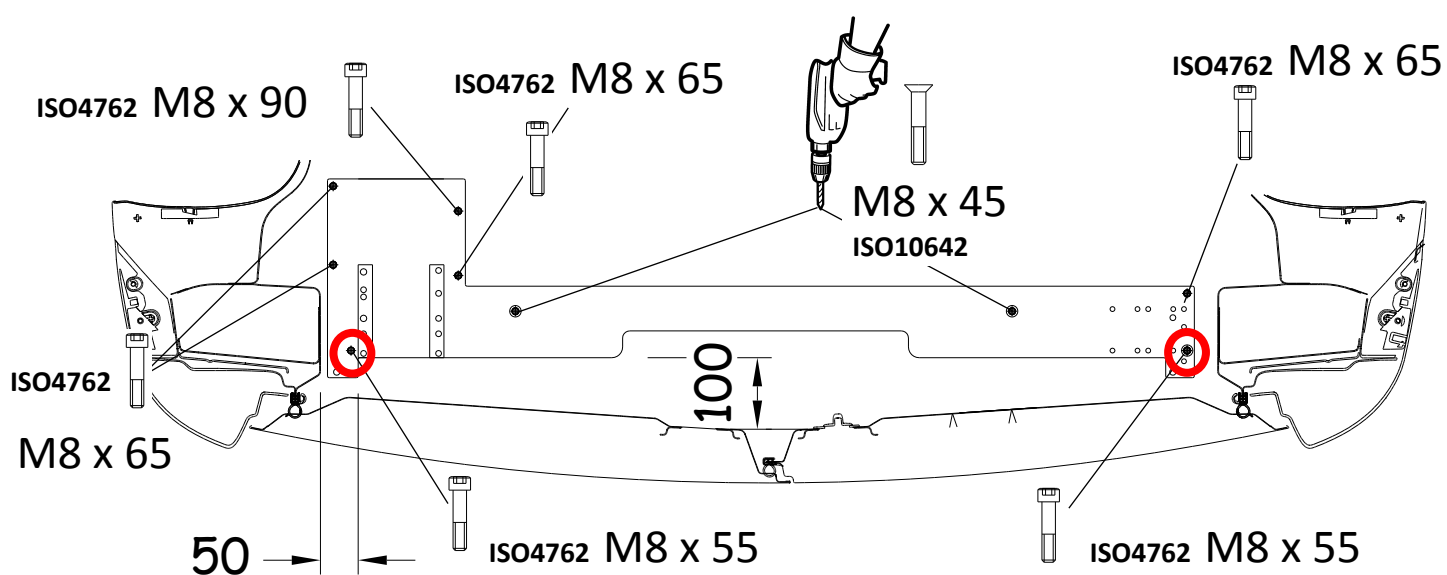

ISO4762	- M8 X130	
ISO4762	- M8X55	
ISO8765	- M8 X45	
ISO4762	- M8 X45	
ISO10642	- M8X40	