

ISTRUCCIONES PARA EL USO DE LAS RAMPAS

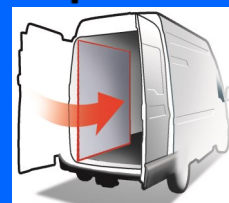

www.wmsystem.com

WM LIGHT PLUS

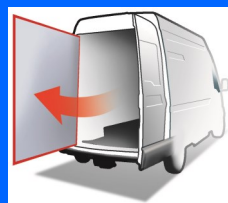
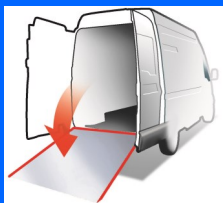

optional

IMPORTANTE

1. ANTES DE UTILIZAR LA RAMPA, ACCIONE EL FRENO DE MANO DEL VEHICULO.
2. CONTROLAR QUE NO SUPONGA UN OBSTACULO PARA OTROS.

CERTIFICADO

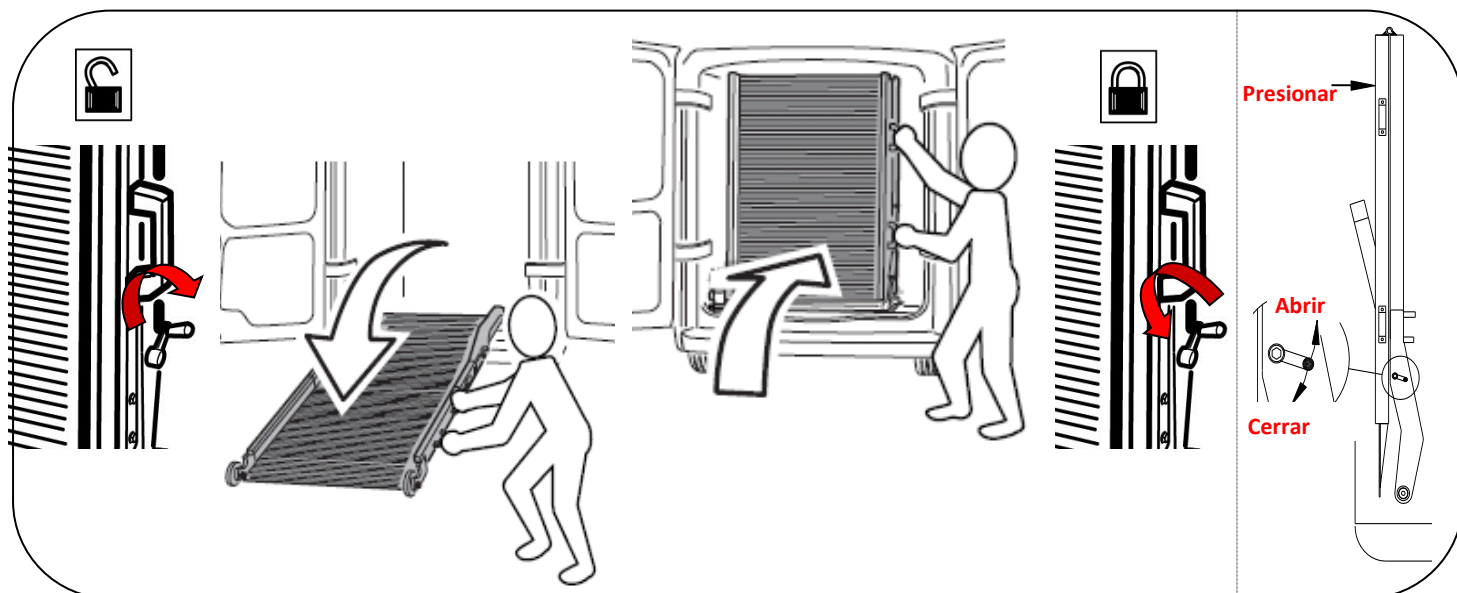

PARA GIRAR LA RAMPA HACIA EL EXTERIOR

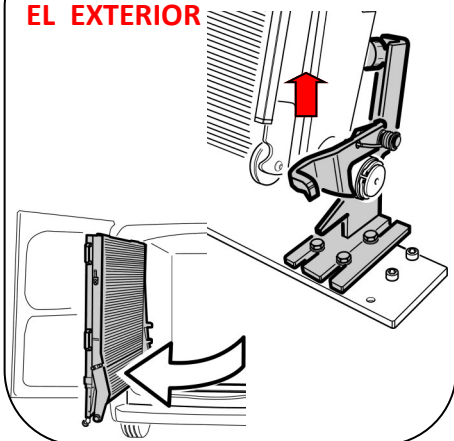

PARA GIRAR LA RAMPA HACIA EL INTERIOR

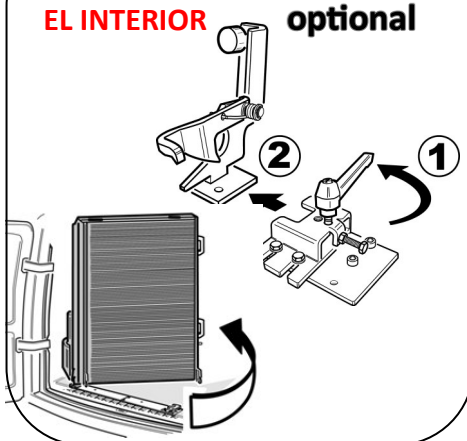

CORREA DE SEGURIDAD

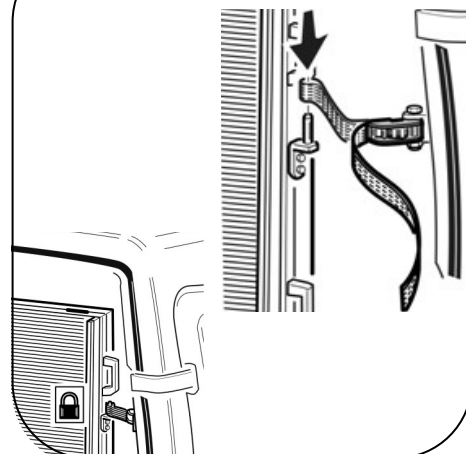

DISTRIBUIDORES

ERKE

erke@erke.biz

www.erke.biz



EQUIPAMIENTO PARA VEHÍCULOS



